



## C9350 Installation Instructions 2007-13 Chevy/GMC, 1/2 Ton, Crew Cab, 2/4wd 3" Body Lift

### Read and understand all instructions and warnings prior to installation of product and operation of vehicle.

Zone Offroad Products recommends this system be installed by a professional technician. In addition to these instructions, professional knowledge of disassembly/ reassembly procedures and post installation checks must be known. Minimum tool requirements include the following: Assorted metric and standard wrenches, hammer, hydraulic floor jack and a set of jack stands. See the "Special Tools Required" section for additional tools needed to complete this installation properly and safely.

#### » PRODUCT SAFETY WARNING

Certain Zone Suspension Products are intended to improve off-road performance. Modifying your vehicle for off-road use may result in the vehicle handling differently than a factory equipped vehicle. Extreme care must be used to prevent loss of control or vehicle rollover. Failure to drive your modified vehicle safely may result in serious injury or death. Zone Offroad Products does not recommend the combined use of suspension lifts, body lifts, or other lifting devices.

You should never operate your modified vehicle under the influence of alcohol or drugs. Always drive your modified vehicle at reduced speeds to ensure your ability to control your vehicle under all driving conditions. Always wear your seat belt.

#### » TECHNICAL SUPPORT

[www.zoneoffroad.com](http://www.zoneoffroad.com) may have additional information about this product including the latest instructions, videos, photos, etc.

Send an e-mail to [tech-zone@sporttruckusainc.com](mailto:tech-zone@sporttruckusainc.com) detailing your issue for a quick response.

888.998.ZONE Call to speak directly with Zone tech support.

#### Difficulty Level

easy 1 2 **3** 4 5 difficult

Estimated installation: 6-8 hours

#### Special Tools Required

None

#### Tire/Wheel Fitment

32 x 12.50 on Factory Wheels

#### » PRE-INSTALLATION NOTES

1. Special literature required: OE Service Manual for model/year of vehicle. Refer to manual for proper disassembly/reassembly procedures of OE and related components.
2. Adhere to recommendations when replacement fasteners, retainers and keepers are called out in the OE manual.
3. Larger rim and tire combinations may increase leverage on suspension, steering, and related components. When selecting combinations larger than OE, consider the additional stress you could be inducing on the OE and related components.
4. Post suspension system vehicles may experience drive line vibrations. Angles may require tuning, slider on shaft may require replacement, shafts may need to be lengthened or trued, and U-joints may need to be replaced.
5. Secure and properly block vehicle prior to installation of Zone Offroad Products. Always wear safety glasses when using power tools.
6. If installation is to be performed without a hoist, Zone Offroad Products recommends rear alterations first.
7. Due to payload options and initial ride height variances, the amount of lift is a base figure. Final ride height dimensions may vary in accordance to original vehicle attitude. Always measure the attitude prior to beginning installation.

rev072517

## Kit Contents

**\*Important\* Verify you have all of the kit components before beginning installation.**

Qty	Part	Qty	Part
14	3" x 3" Body Block	1	Steering Extension
2	3" x 2" Bumper Spacer	1	Ground Strap Extension
2	Front Bumper Bracket	1	Emergency Brake Cable Bracket
2	Front Outside Bumper Bracket	2	Steel Bed Spacers
2	Front Outside Bumper Brkt Spacer	1	Bolt Pack - Body/Bed Mounts
1	Rear Bumper Bracket (drv)	1	Bolt Pack - Rear Bumper
1	Rear Bumper Bracket (pass)	1	Bolt Pack - Misc
		1	#12 Hose Clamp
		1	Loctite

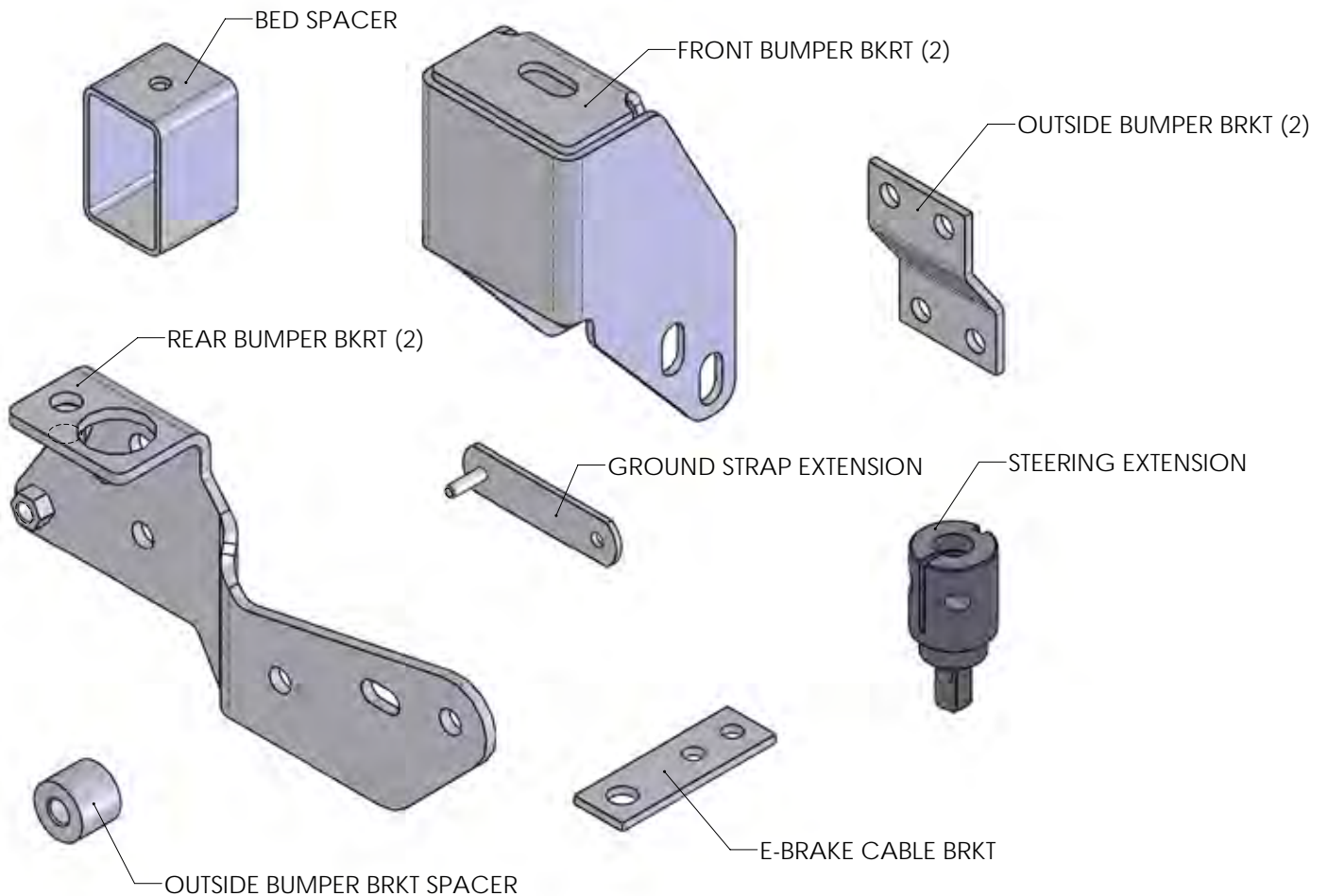

## INSTALLATION INSTRUCTIONS

1. Park the vehicle on a clean, flat surface and block the rear wheels for safety.
2. Remove the negative battery cable first, then the positive battery cable. If equipped, the Supplemental Restraint System (airbags) will be deactivated when the battery is disconnected.
3. Measure and record the space between the bumpers and the body as well as the cab to the bed for reference during the installation.

### FRONT

#### » FRONT DISASSEMBLY

1. Remove the 8 plastic retaining clips holding the upper core support cover to the core support **Figure 1**. Pull up on the center of the clips to unlock and then pull them out of the cover. Save the cover and clips.

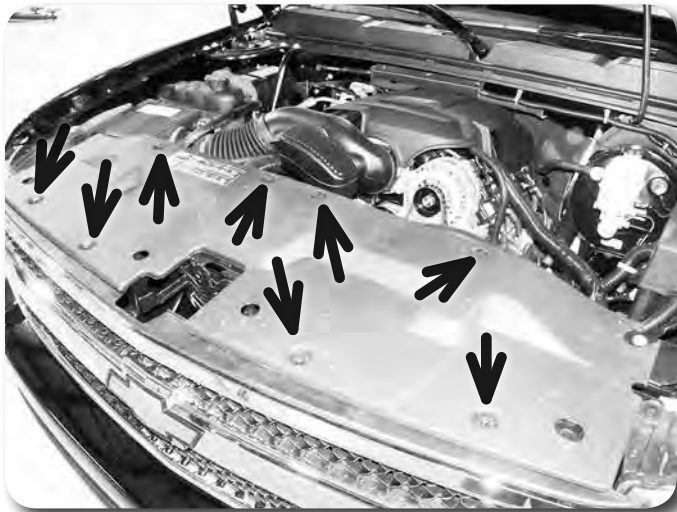

Figure 1

2. Remove the 4 bolts mounting the top of the grill to the core support **Figure 2**. Pull out on the grill (starting at the bottom) to release the retaining clips. Remove the grill from the vehicle.



Figure 2

3. Disconnect the fog light wiring connectors from the fog lights **Figure 3**.

#### **Step 2 Note**

Pliers may be used to compress the clips to help release them.

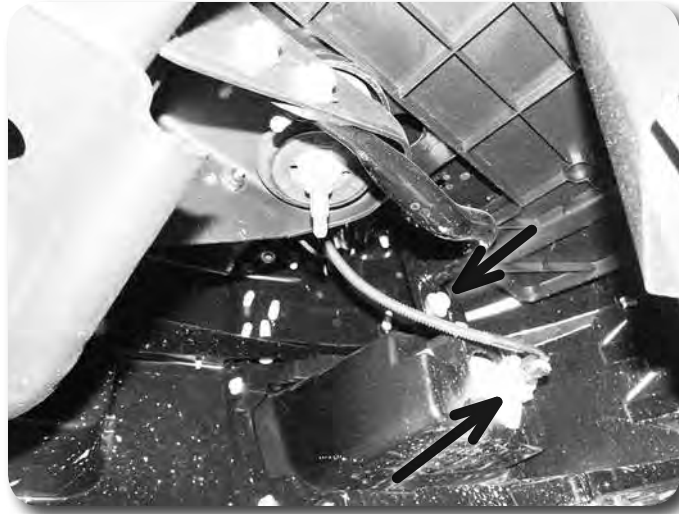

Figure 3

4. Disconnect the outer bumper supports from the bumper **Figure 3**. Save bolts. If equipped, remove the small plastic shroud from the driver's side frame rail **Figure 4** that is positioned directly behind the front body mount. This shroud will be modified before reinstalling later in the installation.

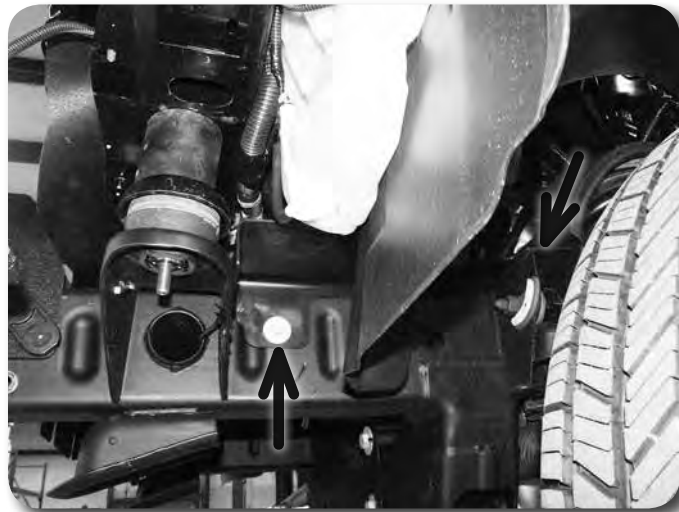

Figure 4

5. Disconnect the rubber core support shroud that runs from the core support **Figure 5**. Disconnect the shroud from the bumper only (4 plastic push-in style retaining clips).
6. Remove the two bumper bolts that mount the bumper to the frame horns **Figure 5** and remove the bumper from the vehicle.



Figure 5

7. Make a small mark on each tow hook to indicate which side is up. Remove the tow hooks from the frame by removing the two (per hook) mounting bolts **Figure 6**. Save the mounting hardware and hooks.
8. Remove the factory front bumper brackets from the frame horns **Figure 6**. Save all hardware.
9. Disconnect the outer bumper supports from the frame. Save hardware and supports.
10. Disconnect the ground wire(s) from the passenger's side front body mount bracket **Figure 6**. Save bolt.



Figure 6

11. Pull up and forward on the plastic engine cover and remove it from the vehicle **Figure 7**.



Figure 7

12. Disconnect the upper radiator hose from the intake tube and the retaining clamp at the top of the radiator Figure 8a/b.



Figure 8a



Figure 8b

13. Disconnect the passenger's side valve cover breather hose from the valve cover **Figure 9**. The opposite end of the breather hose can remain connected to the air intake.

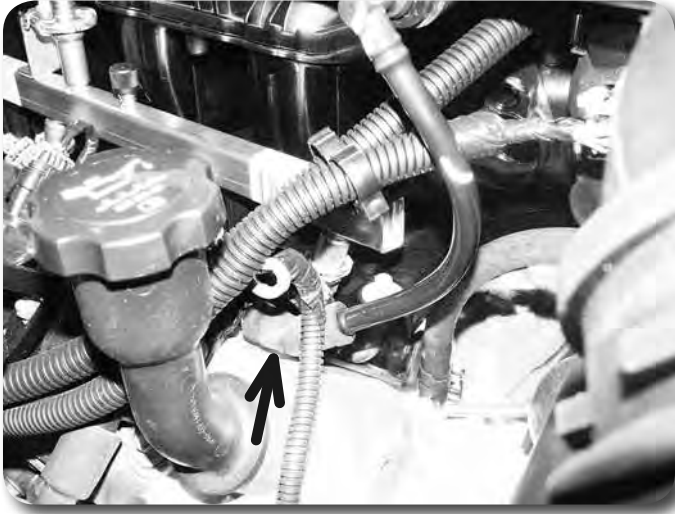

Figure 9

14. Loosen the air intake tube hose clamps at the air box and the throttle body. Remove the intake tube from the vehicle.
15. Disconnect the ground wire from the driver's side firewall **Figure 10**. Save the mounting nut.

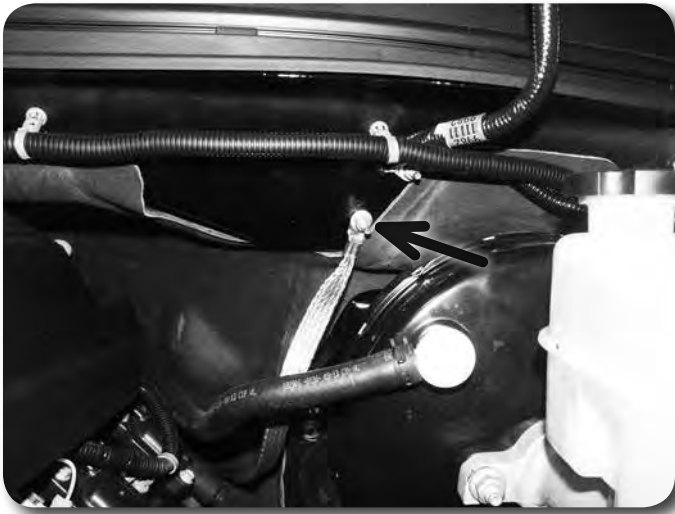

Figure 10

16. Lock the steering wheel. Mark the relationship between the steering shaft and the connecting point at the steering rack on the frame **Figure 11**. Remove the pinch bolt and pull the steering shaft off the steering rack. The upper steering column will collapse into the firewall. Save hardware.

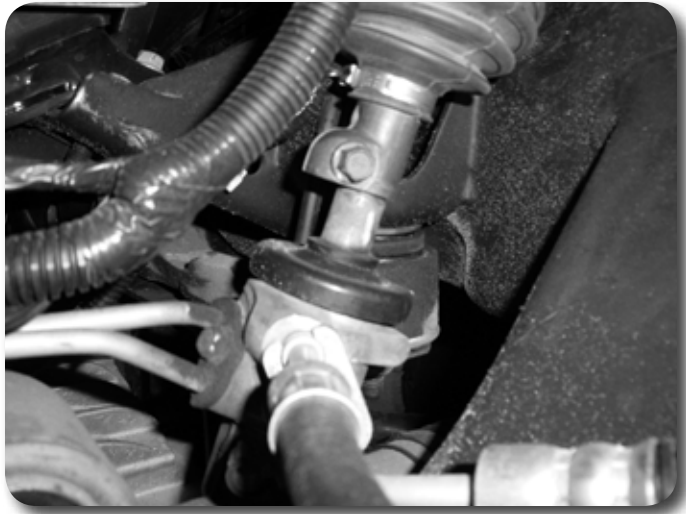

Figure 11

17. If equipped, remove the four bolts mounting the front skid plate to the frame Figure 12. Remove the skid plate from the vehicle. Save skid plate and bolts.

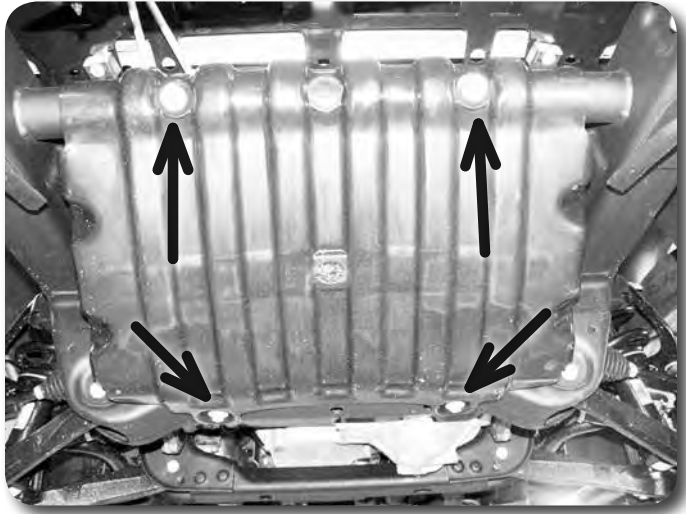

Figure 12

18. Disconnect the starter power wire and the O2 sensor wire from the top of the passenger's side frame rail near the rear of the wheel well opening Figure 13.



Figure 13



19. Pull down on the parking brake cable that runs down the driver's side frame rail. Clamp the cable where it runs through the front body mount so it stays slack  
Figure 14.

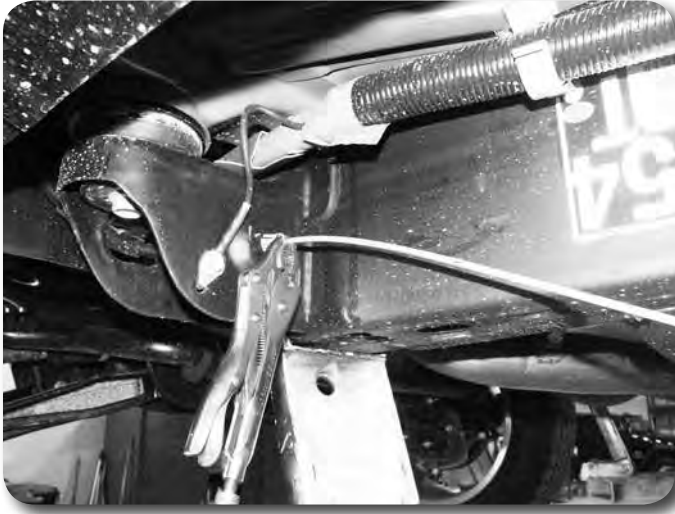

Figure 14

20. Disconnect the front section of the cable from the rear section at the connector just below the driver's side door. There is a small indent in the connector that must be removed to allow that cable to be pulled free Figure 15. Remove the indent with a punch, small rotary grinder or drill.



Figure 15

21. Compress the retaining clip at the body mount and pull the parking brake cable out the front of the mount. It will be relocated and reattached later.
22. Disconnect the large wire harness that runs down the driver's side frame rail from the retaining clip at the rear portion of the front wheel well Figure 16.



Figure 16

23. Check for any other wires, hoses, etc that may not have enough slack for 3" of body lift. Disconnect or reroute these parts as necessary.

### »» CAB LIFT

24. Loosen but do not remove all of the cab mount bolts. The front bolts run from the top down through the core support and are attached with a nut. The remaining bolts run from the bottom up into captive threads in the cab.
25. Remove the passenger's side cab bolts. Be sure to remove the large washer with the front bolt, it will be reused with the new hardware.
26. Using a hydraulic jack and block of wood, slowly lift the passenger's side of the cab. Continuously watch for lines, hoses, etc to be sure none are overextended. Lift the cab just enough to place the provided lift blocks between the body and the frame body mounts. Install the provided 3" diameter blocks in the 4 cab mount positions.
27. Install 14mm x 180mm bolts with the factory lower bushing up through the cab mounts 3 rear cab mount positions. Install a 12mm x 180mm bolt with the factory large flat washer down through the core support and fasten with the factory bushing, 7/16" USS washer and 12mm lock nut. Leave hardware loose.
28. Repeat the lift procedure on the driver's side. Pay close attention to the brake lines running down the top of the frame rail.
29. With the cab lifted, go back and remove each bolt and apply Loctite to the threads. Ensure the body is square on the frame. Torque all 14mm body mount hardware to 95 ft-lbs and the two front 12mm bolts to 65 ft-lbs.

#### Step 27 Note

All cab mount hardware is located in hardware pack #263.

#### Step 29 Note

Use the reference dimensions taken at the beginning of the installation to help align the cab to the bed.

#### Step 30 Note

Steering extension pinch bolt is located in hardware pack #264.

### »» FRONT ASSEMBLY

30. Install a 1/4" set screw into the provided new steering extension on the steering rack. Be sure the extension slides all the way on the rack. Fasten the extension to the shaft with the provided 3/8" x 1-1/4" allen head bolt. Apply Loctite to the bolt threads before installing and torque to 30 ft-lbs., snug the set screw down securely.
31. Slide the upper steering shaft joint down onto the steering extension. Make sure the steering wheel hasn't turned and the alignment marks made earlier still line up. Be sure the joint is all the way on the extension. Fasten the extension to the shaft with the factory pinch bolt (Loctite threads) and torque to 30 ft-lbs  
Figure 17.

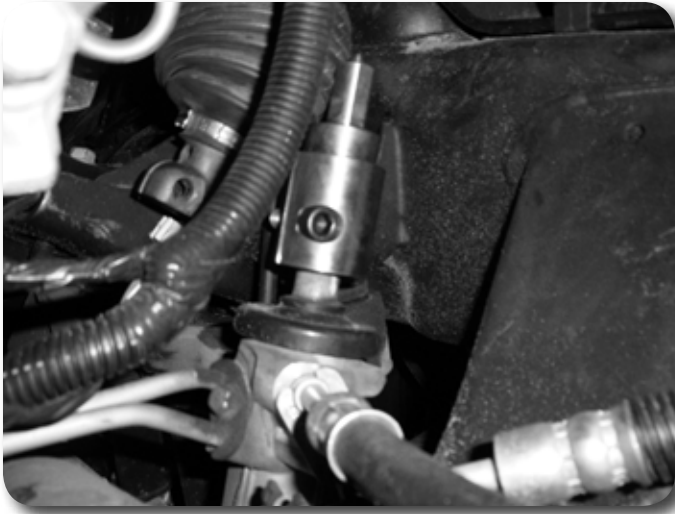

Figure 17

32. Attach the provided ground strap extension to the firewall with the factory nut. The extension will need to mount down and toward the center of the vehicle **Figure 18a,b**. Use serrated edge washer as shown to bite into the strap. Failure to do so may result in a poor ground. Attach the ground strap to the extension with a 1/4" nut and 1/4" USS flat washer (BP 264). Torque the factory and 1/4" nuts to 15 ft-lbs.

**Step 32 Note**  
Ground strap extension hardware is located in hardware pack #264.



Figure 18



Figure 18b

### Step 37 Note

If more slack is needed, carefully pull the wire through the retaining clip on the core support.

33. Reinstall the intake tube to the throttle body and airbox as well as the locating pin on the top of the engine. Tighten the factory hose clamps securely.
34. Reattach the valve cover breather hose to the valve cover.
35. Reattach the upper radiator hose to the clips on the intake tube and top of the radiator.
36. Reinstall the plastic engine cover.
37. Reattach the ground wire(s) that was removed from the front passenger's side body mount bracket. Torque bolt to 15 ft-lbs.
38. Check the transmission cooler lines that run from the front of the vehicle to the passenger's side of the oil pan to be sure they are not rubbing on any components **Figure 19**. If clearance is needed, carefully bend the hardlines up near the point where they attach to the rubber section (near the radiator). Make only small bends by hand, it doesn't take much of a bend to gain adequate clearance.



Figure 19

### Step 41 Note

Each frame rail has three tow hook holes, two on one side and one on the other. Looking at the front of the truck, the single hole should be on the right side of the each frame rail.

39. Reinstall the front skid plate with the factory bolts and torque to 20 ft-lbs.
40. Locate the tow hook drill template at the end of this instruction sheet. Cut the template out along the lines.
41. Place the hole template up to the side of the frame that has only one existing tow hook hole. Position the template on the frame by aligning the front edge with the frame and the existing tow hook hole. Using the template, mark the center of the new rear hole to be drilled. Remove the template and repeat on the other frame rail. Drill a 1/2" hole at each mark (two holes in all).
42. Install the tow hooks in the frame so that they are flipped over from how they were removed (the mark made earlier is now facing down). Install the hooks to the frame using the original front holes and one new back hole with the factory hardware **Figure 20**. The hooks will now angle up slightly as they go toward the front to clear the relocated front bumper. Torque the tow hook bolts to 65 ft-lbs.



Figure 20

43. The front bumper must be trimmed slightly to clear the relocated tow hooks. Locate the tow hook holes in the bumper **Figure 21**. Cut straight down from each edge of the tow hook hole down to the corner where the plastic angles forward. Cut along the corner in the plastic to connect the two downward cuts and remove the material from the bumper.



Figure 21

44. Loosely attach the new provided front bumper brackets to the frame rails with the factory hardware **Figure 22**.



Figure 22

### Step 45 Note

Front bumper support bracket hardware is located in hardware pack #264.

45. Attach the provided outer bumper support relocation brackets to the original support mount location on the frame **Figure 23**. Fasten the brackets with 7/16" x 1" bolts, nuts and 3/8" USS washers. Leave hardware loose.

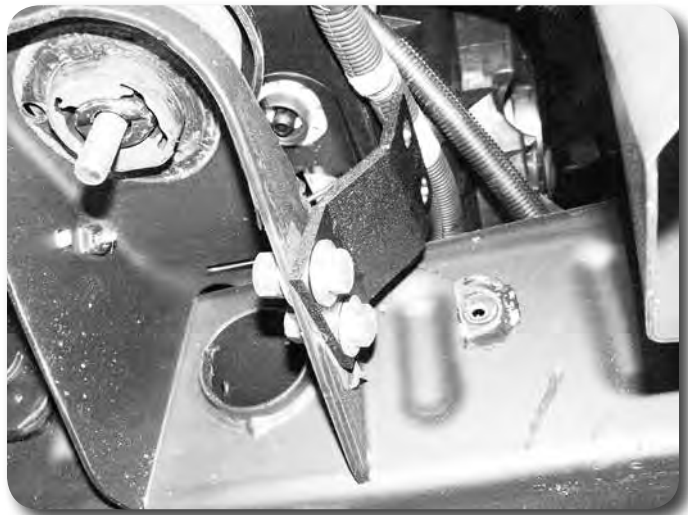

Figure 23

46. Attach the factory outer bumper support to the relocation brackets with the factory bolts. The support should mount to the forward surface of the relocation bracket. Leave hardware loose.
47. Install the bumper on the vehicle and fasten to the main front brackets with the factory bolts. Leave loose.

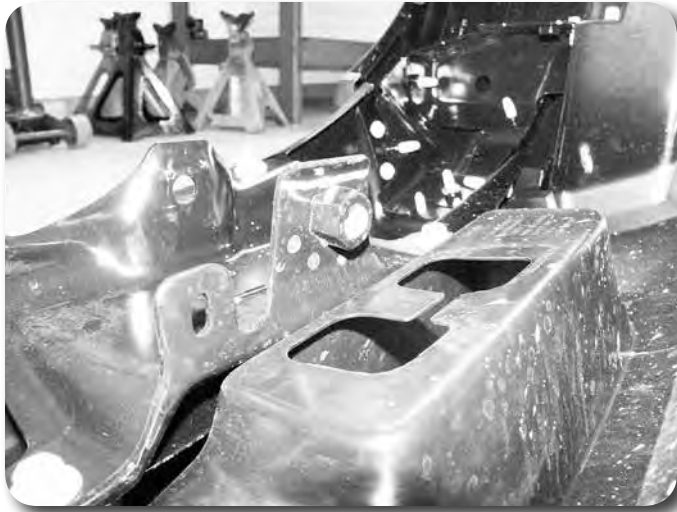

Figure 24

### Step 49 Note

Although rare, if the bumper needs to be adjust downward more then the brackets will allow, remove the bumper and trim the lower mounting tabs on the bumper just behind the welded nut **Figure 24**..

### Step 50 Note

Front bumper support bracket hardware is located in hardware pack #264.

48. Adjust the bumper side to side and tighten the two main bolts mounting the bumper to the new brackets. Torque bolts to 65 ft-lbs.
49. Adjust the bumper vertically and tighten the four bolts/nuts mounting the new brackets to the frame. Torque nuts to 95 ft-lbs.
50. Attach the outer bumper supports to the bumper by first placing the provided 1" spacer between the bumper and the support **Figure 25**. Fasten the support and spacer with a 10mm x 50mm bolt and 3/8" USS washer (BP 264) into the captive nut in the bumper. Apply Loctite to the bolt threads and torque to 40 ft-lbs.



Figure 25

51. The driver's side frame shroud that was removed needs to be trimmed to clear the new front bumper outer support bracket position. Hold the shroud up to the bracket and mark where it needs to be trimmed. Trim the shroud and reinstall it with the factory hardware on the frame and upper control arm pocket. Tighten hardware securely.
52. Reattach the core support shroud to the bumper with the original plastic push-in fasteners.
53. Reconnect the fog light wire connectors to the fog lights.
54. Install the grill by pushing the retaining clips back in place. Fasten the grill to the top of the core support with the 4 factory bolts. Tighten the bolts securely.

55. Install the upper core support cover with the 8 factory plastic retainers.
56. Reroute the parking brake cable over the frame body mount that it was installed in. Install the provided parking brake cable bracket on the cable **Figure 26**. Place the bracket against the frame and mark the holes to be drilled. Be sure that bracket/cable does not rub against any wires.



Figure 26

57. Drill 3/8" holes at each mark made for the parking brake bracket. Fasten the bracket to the frame with 3/8" x 1" bolts, nuts and 3/8" SAE washers. Torque bolts to 30 ft-lbs.
58. Pull slack on the parking brake cable and clamp it off like it was during disassembly. Reconnect the front cable to the rear cable and remove the clamp.

### Step 57 Note

Parking brake bracket hardware is located in hardware pack #264.

### Step 1 Note

Reusing the spare tire carrier will require a 1" hole to be drilled in the bumper just below the existing access hole for the winch crank (outlined later in the instructions). If you do not wish to perform this modification and/or retain function of the spare tire carrier then crank the winch up and out of the way.

## REAR INSTALLATION

### » REAR DISASSEMBLY

1. Lower the spare tire and remove it from the vehicle.
2. Locate the rear wire connector cluster on the rear, driver's side frame cross-member **Figure 27**. Disconnect the license plate light harness and back-up sensor harness (if equipped).

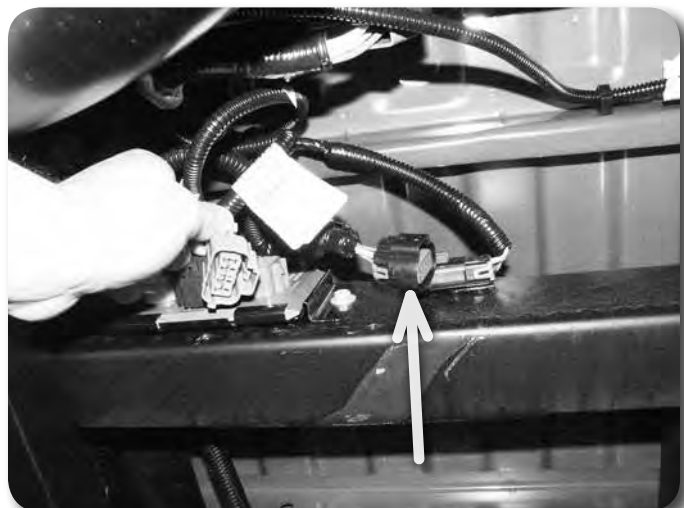

Figure 27



3. If equipped, disconnect the trailer wiring connector from the bumper Figure 28.



Figure 28

4. If equipped, remove the two bolts mounting the rear bumper to the receiver hitch Figure 29.

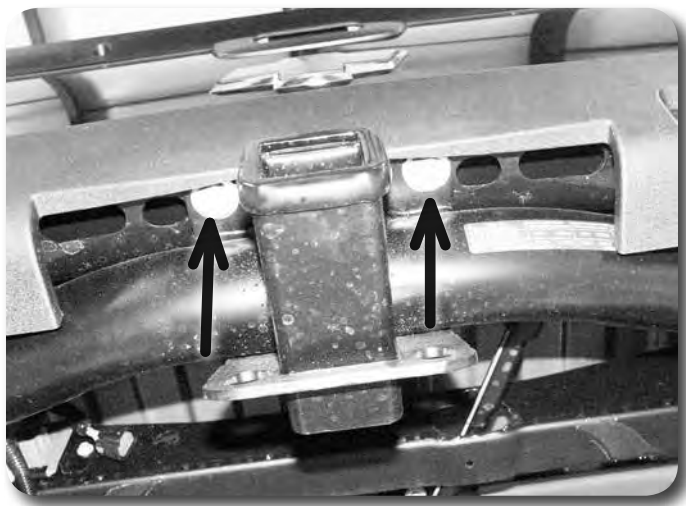

Figure 29

5. Remove the 4 bolts (8 total) mounting the rear bumper to the frame rails. 3 are accessed from the side of the frame Figure 30a and one up through the bottom Figure 30b. Remove the bumper from the vehicle. Save all hardware.



Figure 30a



Figure 30b

6. Disconnect the fuel filler neck from the body by removing the 3 mounting screws Figure 31. Save mounting screws.

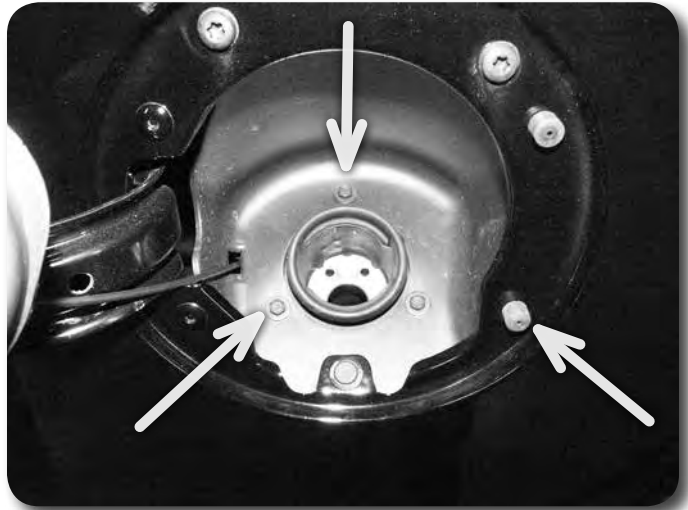

Figure 31

7. Loosen but do not remove all bed mounting bolts. All the bolts mount from the bottom up into captive nuts.
8. Remove the passenger's side bed mounting bolts. With a hydraulic jack and block of wood, slowly raise the bed just high enough to place the provided lift blocks between the frame and the bed. Place the blocks at the bed bolt locations. Loosely fasten the bed/spacers with 12mm x 100mm bolts and 7/16" USS washers.
9. Repeat the bed lift procedure on the driver's side. Make sure the fuel filler neck falls through the body.
10. Remove the plastic bed pads Figure 32a where the bed crossmember rested on the frame at the rear wheel well (one per side). Install the provided rectangular steel bed spacers where the plastic pads were located and fasten with a 5/16" x 1" self-tapping bolt and 5/16" USS washer in the existing frame hole Figure 32b Torque bolt to 20 ft-lbs.

### Step 8 Note

All bed mount hardware is located in hardware pack #263.

### Step 10 Note

Bed spacer hardware is located in hardware pack #263.

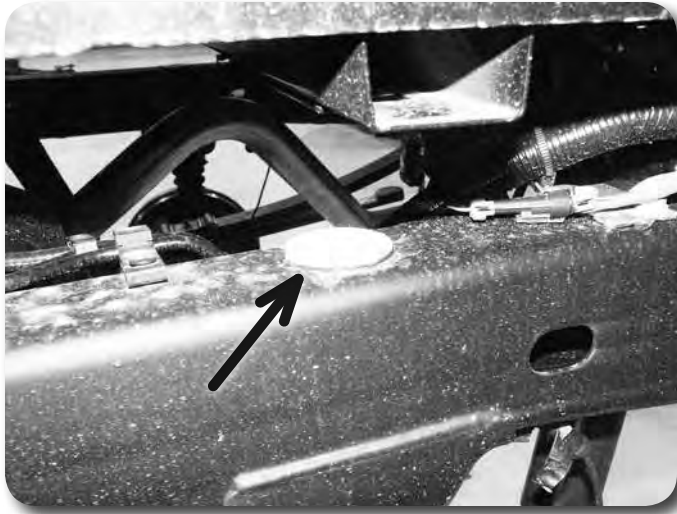

Figure 32a



Figure 32b

11. With the bed lift complete, go back and remove each bolt one at a time and apply Loctite to the threads. Adjust the bed to cab clearance and torque bolts to 65 ft-lbs.

---

## » REAR ASSEMBLY

12. The rear bumper must be modified to install the new rear bumper brackets. Measure back on bracket from the edge of the bottom tab (tab that goes against the bottom surface of the frame) 4-1/2" and make a vertical cut line **Figure 33**. Cut the end of the bracket off along the line. Remove any burrs and paint exposed metal to prevent corrosion. *Note: Bumper is shown upside down in picture.*



Figure 33

### Step 13 Note

All new rear bumper bracket hardware is located in hardware pack #265.

13. Locate the existing hole and slot in the bumper bracket that was trimmed **Figure 34**. These are located farther inside the bumper. Attach the new provided bumper brackets to the bumper using these existing holes and slots. Fasten the new brackets to the factory bracket with  $\frac{1}{2}$ " x  $1\text{-}1/4$ " bolts, nuts and  $\frac{1}{2}$ " SAE washer. The brackets should mount to the inside surface of the factory bracket and offset toward the outside of the bumper **Figure 35**. Adjust the brackets so they are visually square with the top edge of the factory bracket and snug hardware.

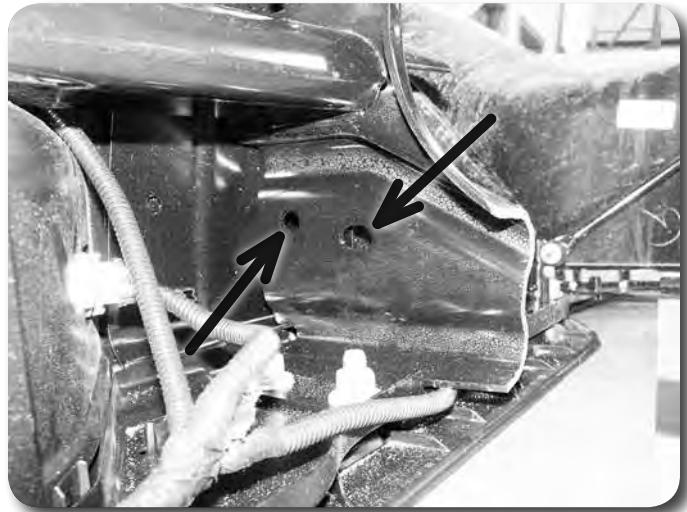

Figure 34

14. Using the new bumper brackets as templates. Mark the third bracket mounting hole to be drilled **Figure 35**. Remove the brackets and drill a  $9/16$ " at each mark.

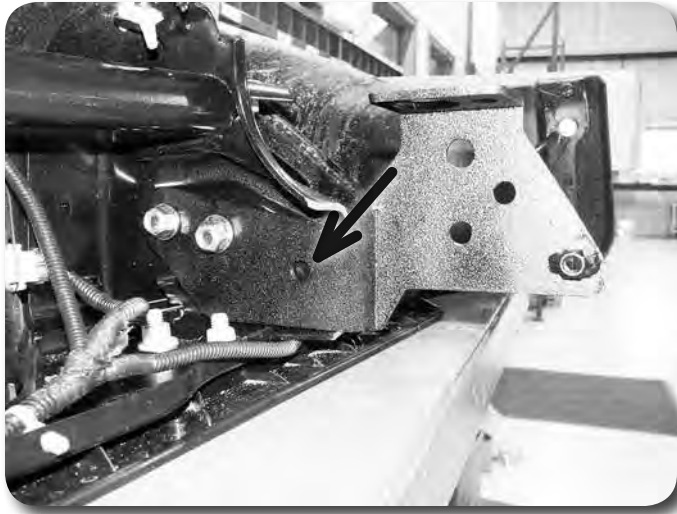

Figure 35

15. Reinstall the bumper brackets on the bumper with the same hardware along with an additional 1/2" x 1-1/4" bolt, nut and washers for the hole just drilled. Leave hardware loose.
16. Install the modified rear bumper in the vehicle **Figure 36** with all of the original frame mount hardware (4 bolts per side). Leave hardware loose.

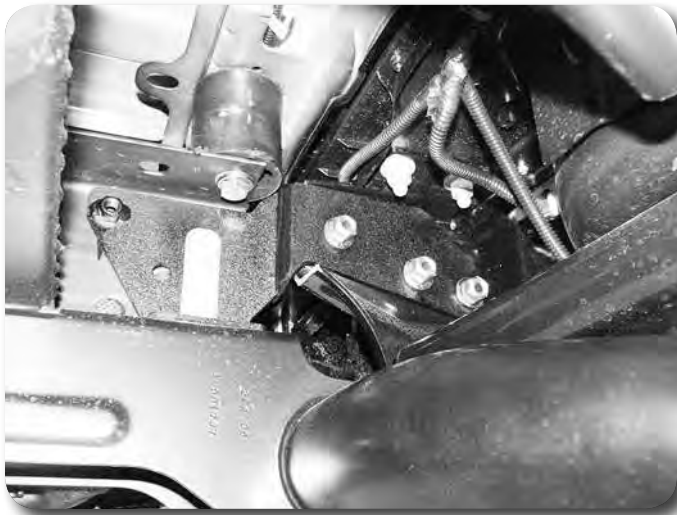

Figure 36

17. If equipped, install the provided 3" tall x 2" OD bumper spacers between the receiver hitch and the bumper. Fasten the bumper to the hitch with 14mm x 110mm bolts and 9/16" SAE washers. Leave loose.
18. Remove the three factory bumper bolts (not bolt tab) on each side one at a time, apply Loctite to threads and reinstall. If installed, do the same for the new 14mm x 110mm bolts.
19. Adjust the bumper to the proper location and tighten all mounting hardware starting with the bumper-to-bracket hardware first. Torque the hardware to the following specs: 1/2" and 12mm hardware – 65 ft-lbs, 14mm hardware – 95 ft-lbs, and 10mm hardware – 40 ft-lbs.
20. Bumper Modification for Spare Tire Carrier: Measure down from the center of the existing spare tire crank hole 2-1/2" and mark **Figure 37**. Using a 1" hole saw, cut a hole in the vertical face of the bumper at the mark. The hole will go through plastic and a section of sheet metal. Clean the burrs from the edges of

### Step 17 Note

The bumper spacers are similar to the body lift spacer, just small OD. The spacer hardware is located in hardware pack #265.

the hole. Attach the spare tire winch tube to the tab directly above it on the frame crossmember with the provided #12 hose clamp **Figure 38**. Secure the tube to the tab by tightening the clamp. Do not over-tighten, which will crush the tube.

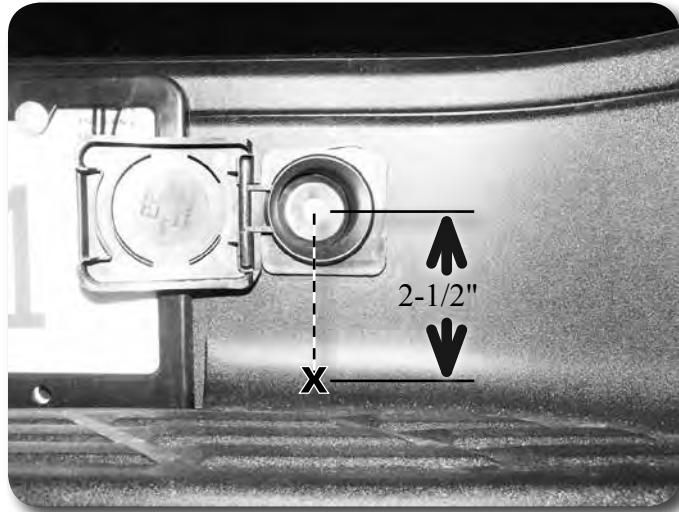

Figure 37

## Post-Installation Warnings

1. Check all fasteners for proper torque. Check to ensure for adequate clearance between all rotating, mobile, fixed, and heated members. Verify clearance between exhaust and brake lines, fuel lines, fuel tank, floor boards and wiring harness. Check steering gear for clearance. Test and inspect brake system.

2. Perform steering sweep to ensure front brake hoses have adequate slack and do not contact any rotating, mobile or heated members. Inspect rear brake hoses at full extension for adequate slack. Failure to perform hose check/replacement may result in component failure. Longer replacement hoses, if needed can be purchased from a local parts supplier.

3. Perform head light check and adjustment.

4. Re-torque all fasteners after 100 miles. Always inspect fasteners and components during routine servicing.



Figure 38

21. Reconnect all bumper wiring.
22. Reattach the fuel filler neck to the body with the factory screws. If slack is needed, loosen the hose clamps on the filler neck and pull some out of the hose. Retighten the hose clamps securely.

## Post-Installation

1. Check all hardware for proper torque.
2. Reconnect battery.
3. Check hardware after 500 miles.
4. Adjust headlights.

